

CAVITIES-TOOLING

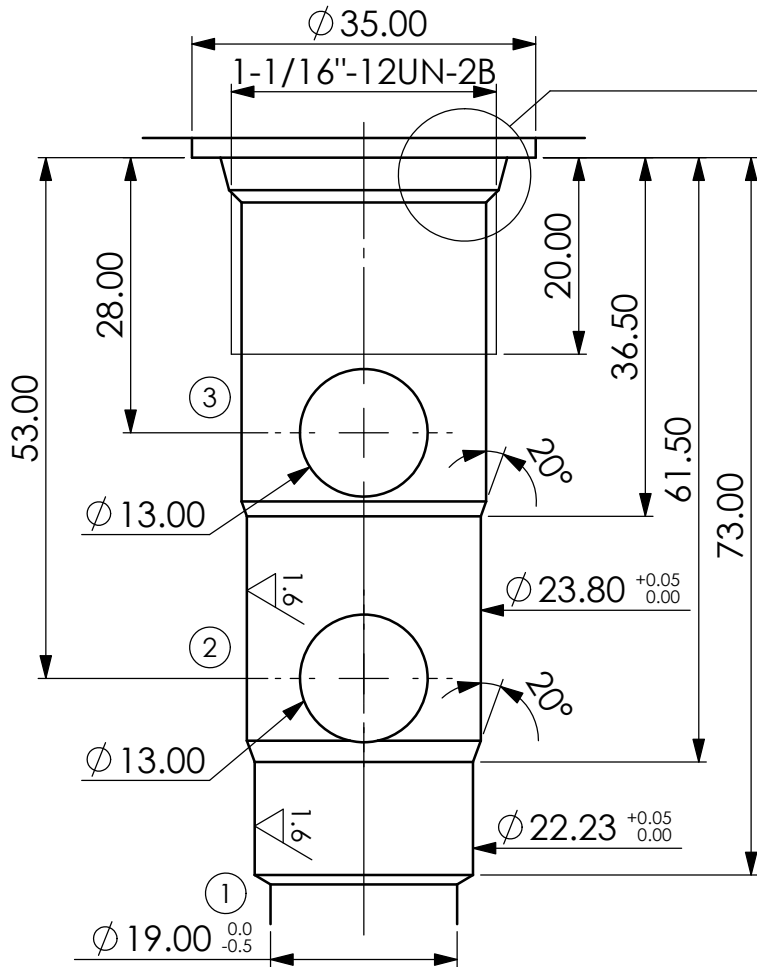

Cavity-Tooling: 12W-3

	0.03
	0.02

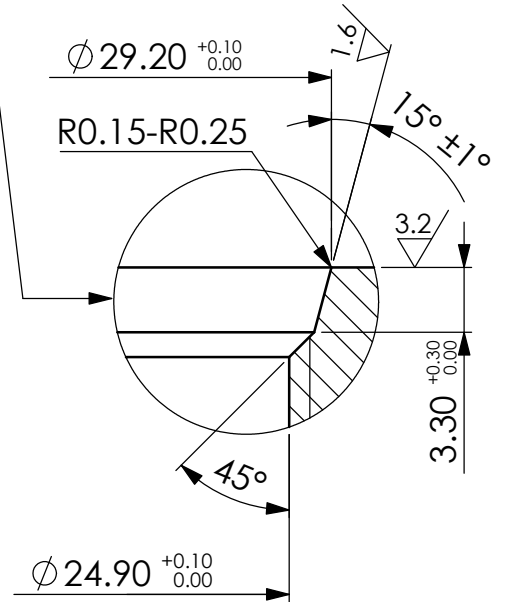

General tolerance: ±0.3
UNIT:mm

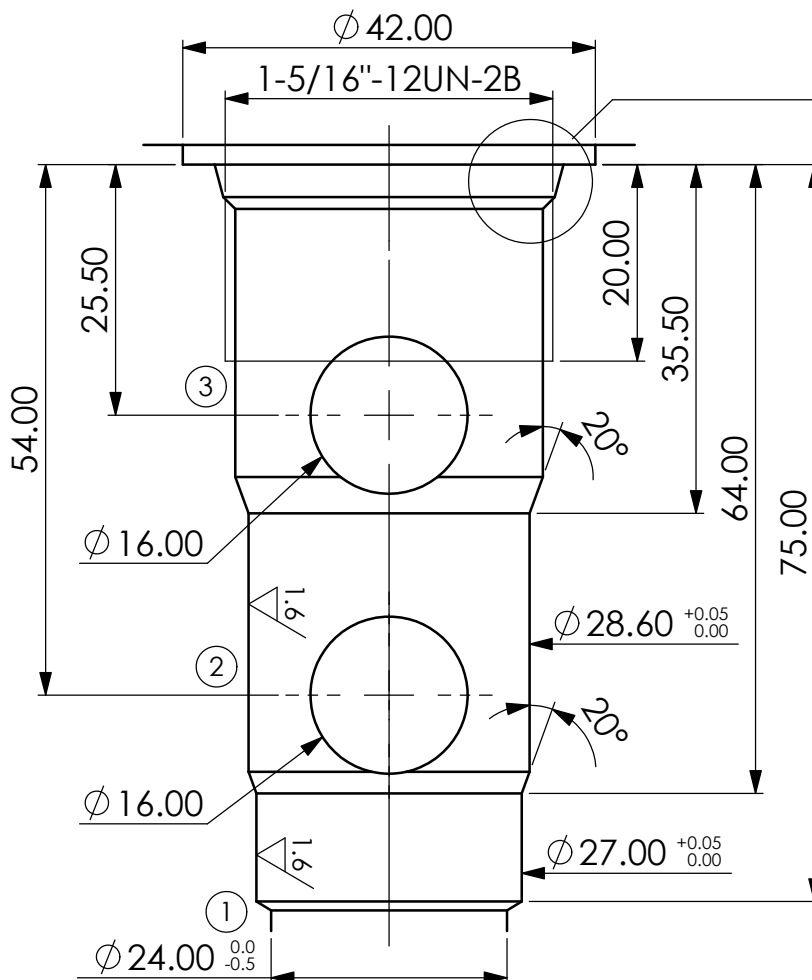

Cavity-Tooling: 16W-3

	0.03
	0.02

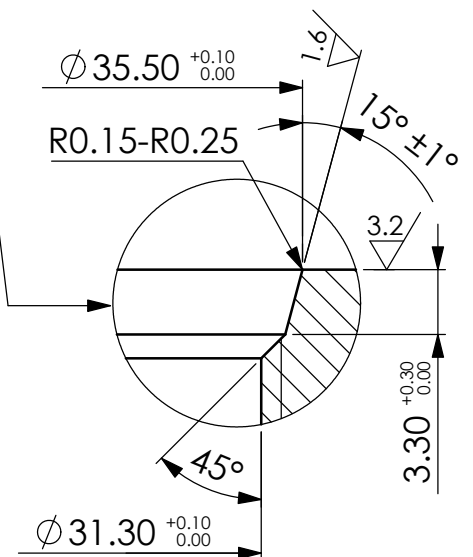

General tolerance: ±0.3
UNIT:mm