

Cavity-Tooling:12W-2

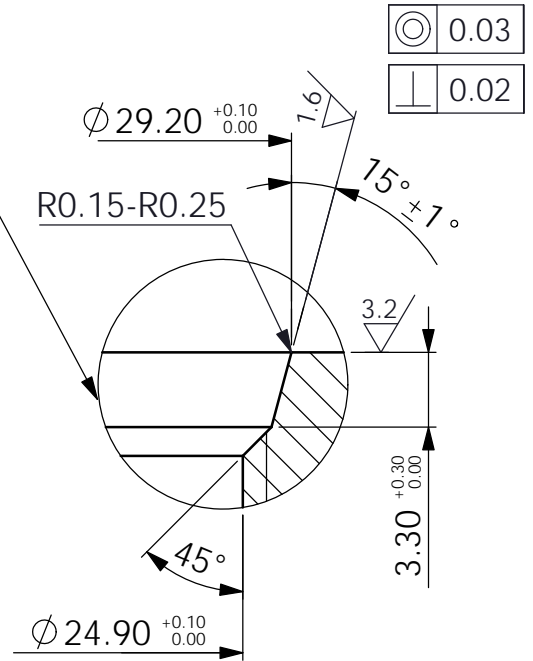
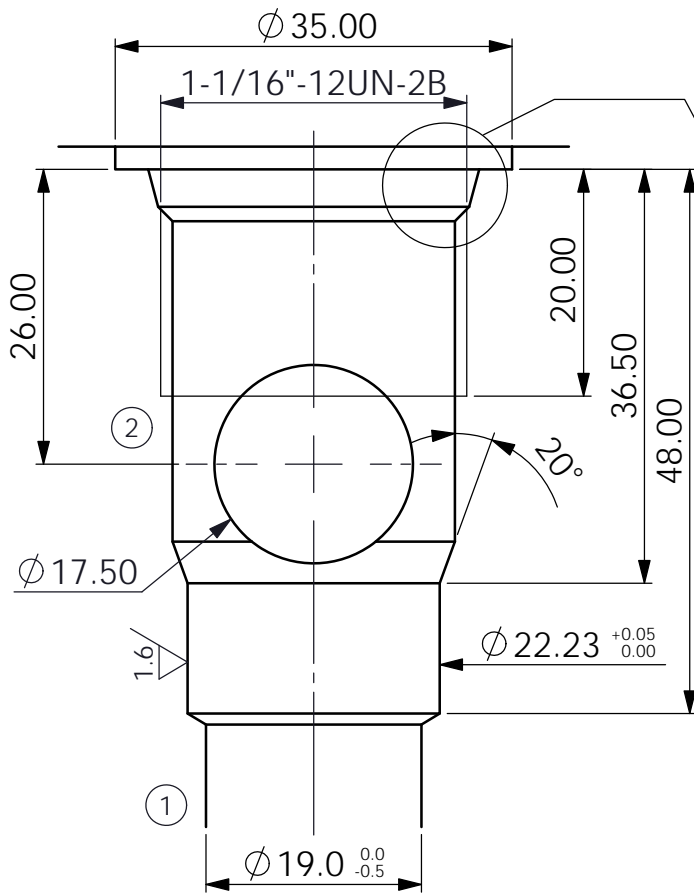

	0.03
	0.02

UNIT:mm

Cavity-Tooling:16W-2

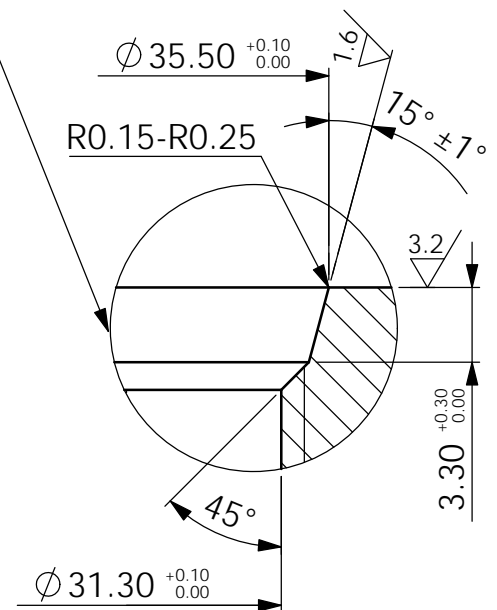
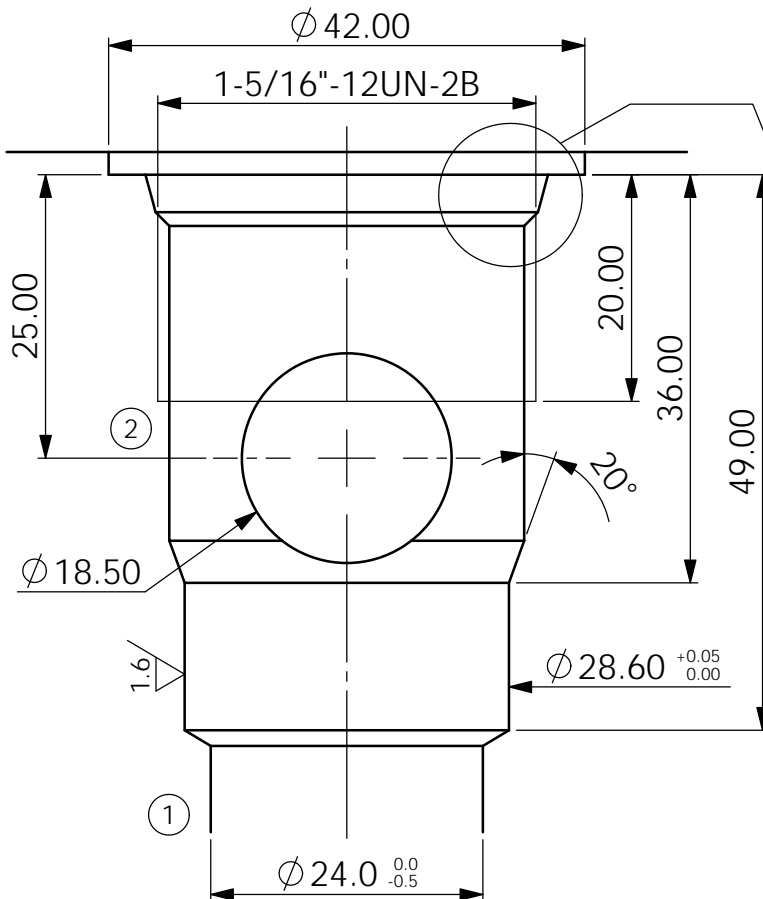

	0.03
	0.02

UNIT:mm