

Cavity-Tooling:08W-4

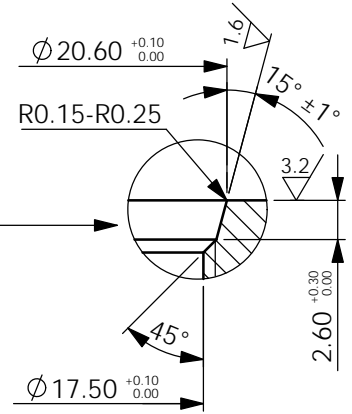
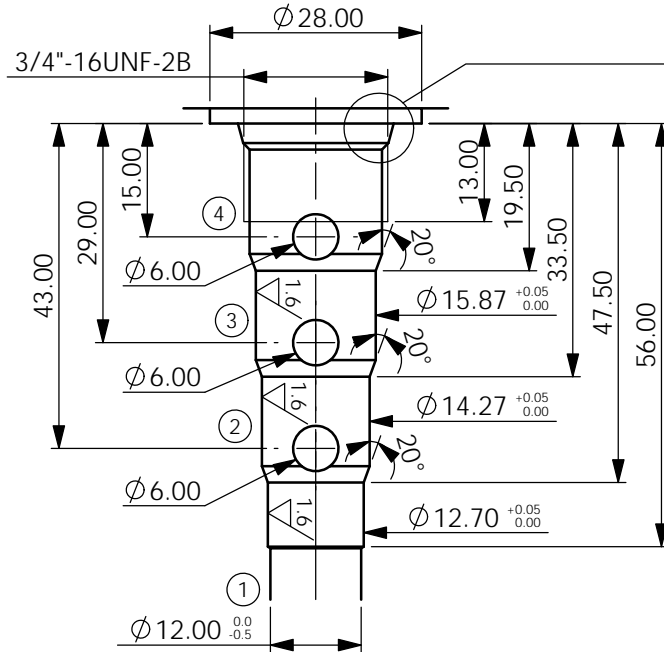

	0.03
	0.02

UNIT:mm

Cavity-Tooling:10W-4

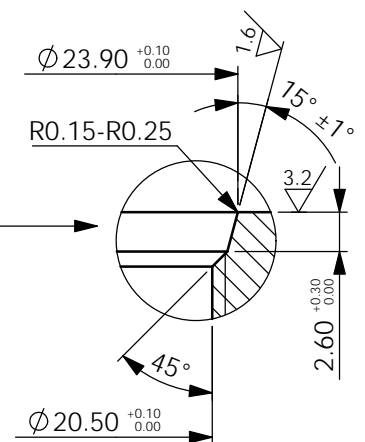
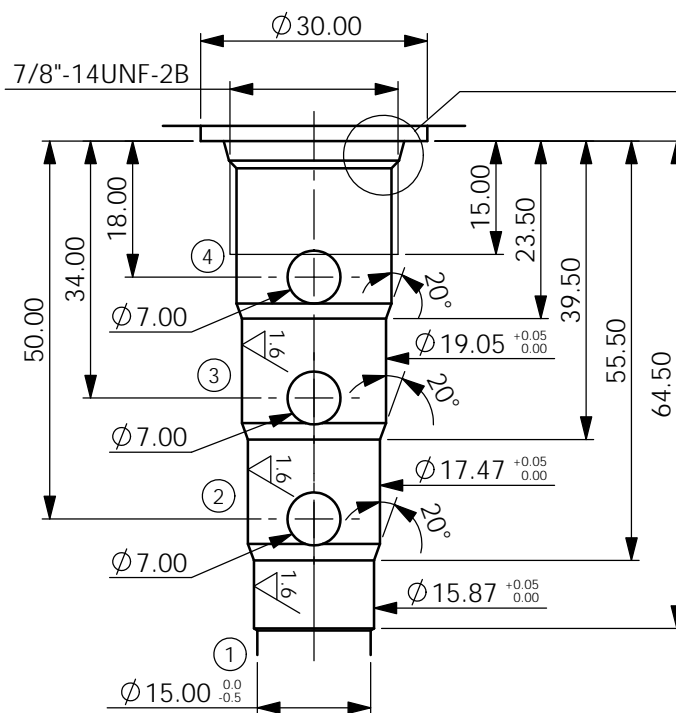

	0.03
	0.02

UNIT:mm