

Cavity-Tooling:10A-2

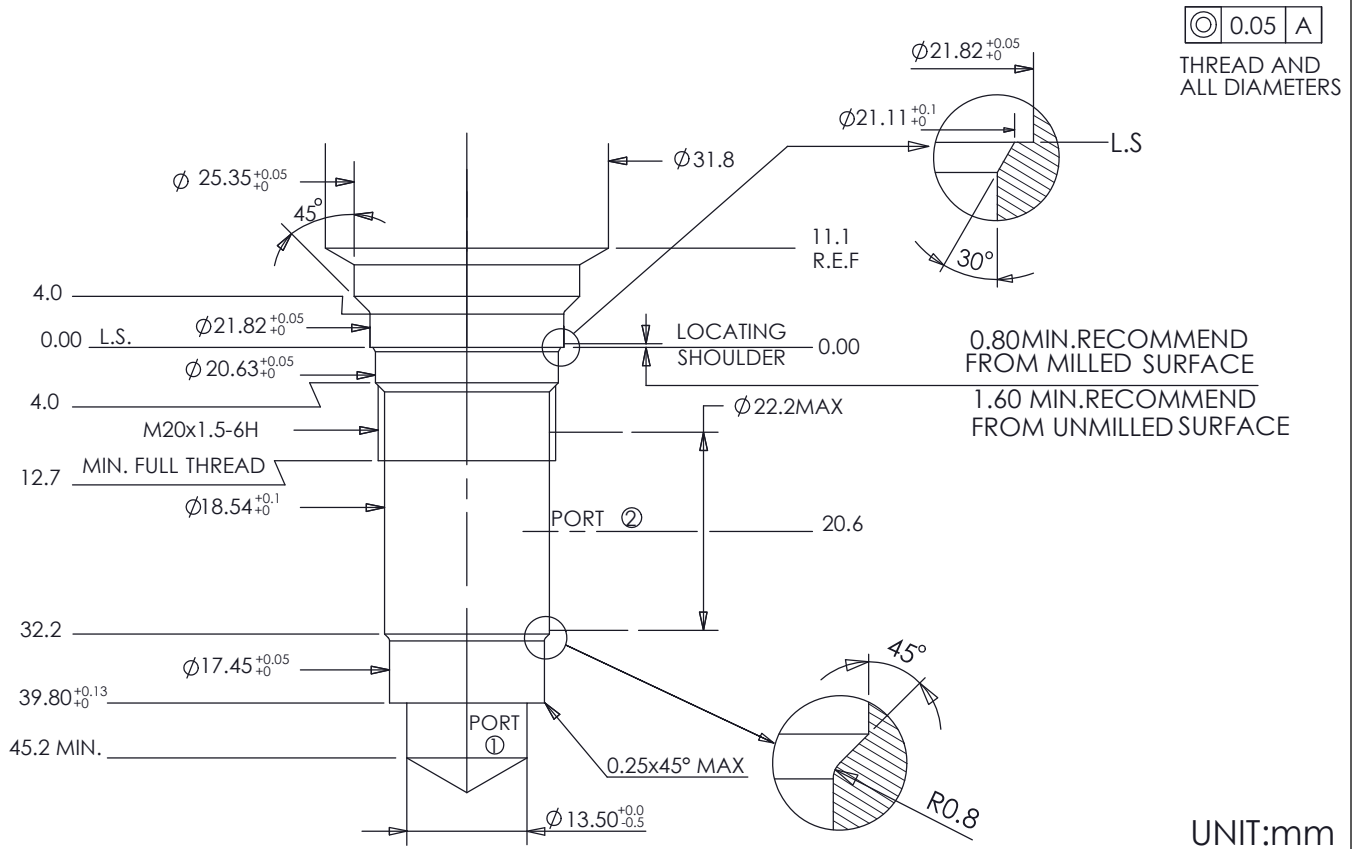

Cavity-Tooling:3A-2

